

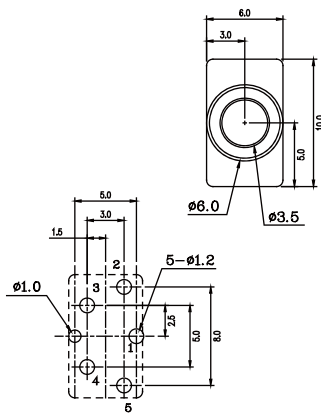

Ø3.5 Earphone Jack Conn.

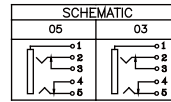

Recommended PCB Layout
(PCB TOLERANCE ±0.05)

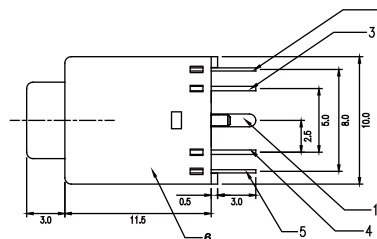
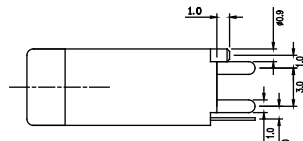

Table

MODEL NO.	EPJ35-0015P-05X-L (COLOR)					
	PK	LU	W	Y	OR	
HOUSING COLOR	BLACK	PINK	LIGHT BLUE	LIME	YELLOW	ORANGE
PANTONE	701C	284C	577C	123C	157C	



NO.	NAME	MATERIAL	FINISH	Q'TY
1	EARTH TERMINAL	PBS t=0.3	TIN PLATED	1
2	TIP SPRING	PBS t=0.25	TIN PLATED	1
3	RING SHUNT	BRASS t=0.3	TIN PLATED	1
4	RING SHUNT	BRASS t=0.3	TIN PLATED	1
5	TIP SPRING	PBS t=0.25	TIN PLATED	1
6	HOUSING	PBT+FIBRE		1

Part No.:EPJ35-0015P--L
 No. of Contacts(03,05) -L
 See Table

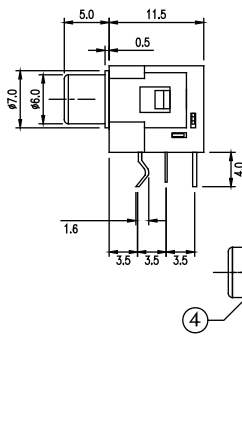

Recommended PCB Layout
(PCB TOLERANCE ±0.05)

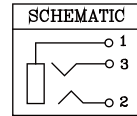
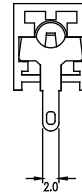
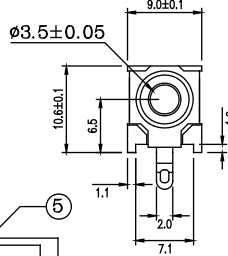

NO.	NAME	MATERIAL	FINISH	Q'TY
1	GROUND TERM.	C.R.S. 0.4THK	TIN PLATED	1
2	RING TERM.	BRASS 0.5THK	TIN PLATED	1
3	TIP TERM.	PHOS. BRONZE 0.25THK	TIN PLATED	1
4	BUSHING	BRASS	NICKEL PLATED	1
5	HOUSING	PBT	BLACK	1



Part No.:EPJ35-2017A-03TB-L

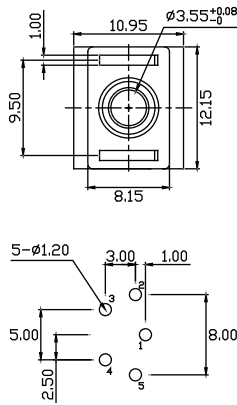

Recommended PCB Layout
(PCB TOLERANCE ±0.05)

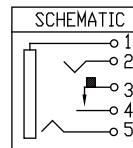
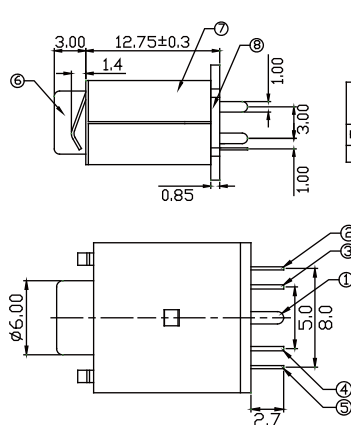

Table

MODEL NO.	EPJ35-2506SP-05X-L(COLOR)					
	PK	U	W	Y	DR	LU
HOUSING COLOR	PINK	BLACK	LIME	YELLOW	ORANGE	LIGHT BLUE
PANTONE	701C		577C	123C	157C	284C

NO.	NAME	MATERIAL	FINISH	Q'TY
1	PIN1	PHOS.BRONZE T0.25	TIN PLATED	1
2	PIN2	PHOS.BRONZE T0.25	TIN PLATED	1
3	PIN3	BRASS T0.30	SILVER PLATED	1
4	PIN4	PHOS.BRONZE T0.30	SILVER PLATED	1
5	PIN5	PHOS.BRONZE T0.25	TIN PLATED	1
6	HOUSING	NYLON PA66	SEE COLOR	1
7	SHELL	STAINLESS T0.2	LIME	1
8	BOTTOM COVER	PBT G.F.	LIME	1



Part No.:EPJ35-2506SP-05T-L
 See Table

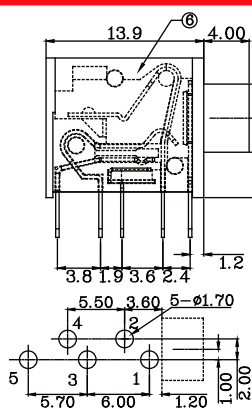

Recommended PCB Layout
(PCB TOLERANCE ±0.05)

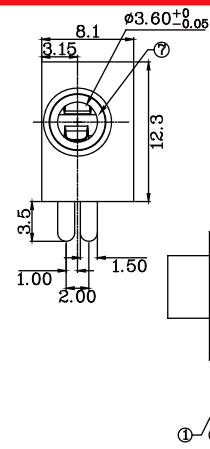

NO.	NAME	MATERIAL	FINISH	Q'TY
1	PIN1	BRASS t=0.3	TIN PLATED	1
2	PIN2	PHOSFOR BRONZE t=0.30	TIN PLATED	1
3	PIN3	PHOSFOR BRONZE t=0.25	TIN PLATED	1
4	PIN4	PHOSFOR BRONZE t=0.30	TIN PLATED	1
5	PIN5	PHOSFOR BRONZE t=0.30	TIN PLATED	1
6	COVER	PBT+FIBRE		1
7	BUSHING	BRASS	NICKEL PLATED	1
8	HOUSING	PBT+FIBRE		1

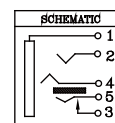

Table

NO.	EPJ35-2508P-05X-L	PANTONE
PK	PINK	701C
U	BLACK	
W	LIME	577C
Y	YELLOW	123C
OR	ORANGE	157C
LU	LIGHT BLUE	284C



Part No.:EPJ35-2508P-05-L
 See Table