

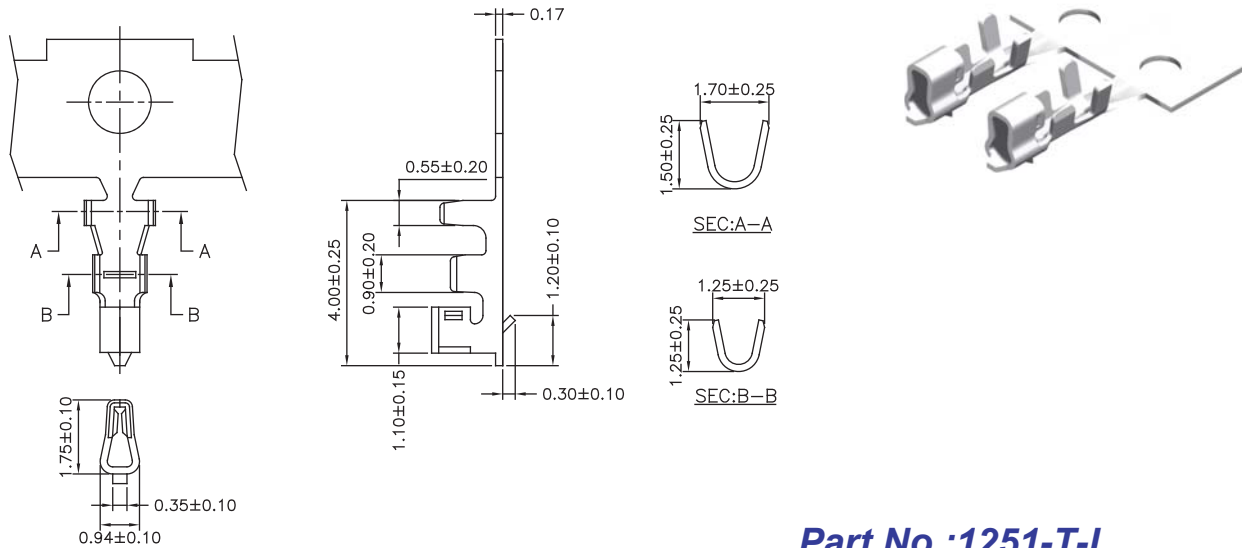

1.25mm Terminal / Housing



Part No.:1251-T-L

Wire Range	Insulation O.D.	Material	Finish
AWG#28-#32	1.00mm(max)	Phosphor Bronze	Tin-plated

Specifications

Current Rating: 1A AC,DC
 Voltage Rating: 200V AC,DC
 Temperature Range: -25°C to +85°C
 Contact Resistance: 20mΩ Max
 Insulation Resistance: 100MΩ Min
 Withstanding Voltage: 500V AC/minute
 Material:Nylon 66,UL94V-0

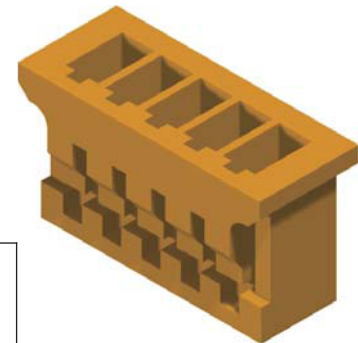

Part No.	Dimensions	
	A	B
1251H-02R-L	1.25	3.95
1251H-03R-L	2.50	5.20
1251H-04R-L	3.75	6.45
1251H-05R-L	5.00	7.70
1251H-06R-L	6.25	8.95
1251H-07R-L	7.50	10.20
1251H-08R-L	8.75	11.45
1251H-09R-L	10.00	12.70
1251H-10R-L	11.25	13.95
1251H-11R-L	12.50	15.20
1251H-12R-L	13.75	16.45
1251H-13R-L	15.00	17.70
1251H-14R-L	16.25	18.95
1251H-15R-L	17.50	20.20

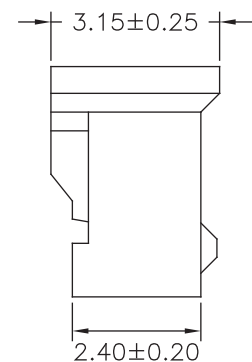
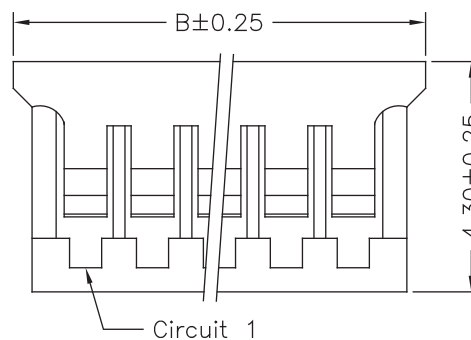
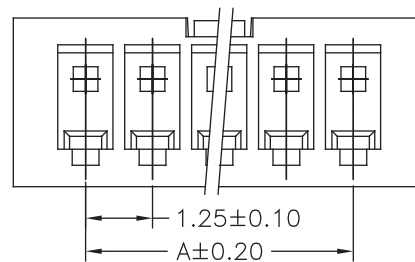

Part No.:1251H-XXR-L



1.25mm Wafer Right Angle / Straight Type

Specifications

Current Rating: 1A AC,DC
 Voltage Rating: 200V AC,DC
 Temperature Range: -25°C to +85°C
 Contact Resistance: 20mΩ Max
 Insulation Resistance: 100MΩ Min
 Withstanding Voltage: 500V AC/minute
 Terminal: Brass / Tin Plated
 Material:Nylon 66,UL94V-0

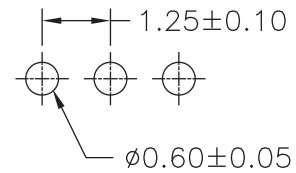
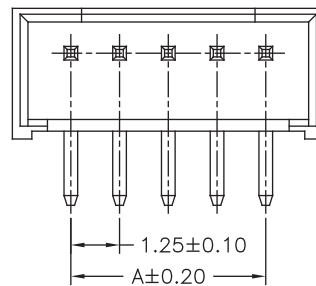
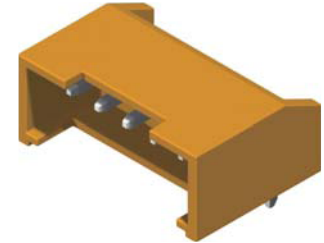

P.C.B LAYOUT

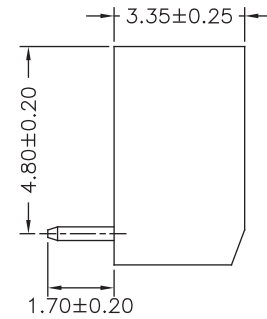
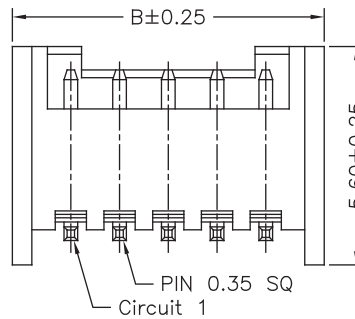

Part No.:1251R-XXTR-L

Specifications

Current Rating: 1A AC,DC
 Voltage Rating: 200V AC,DC
 Temperature Range: -25°C to +85°C
 Contact Resistance: 20mΩ Max
 Insulation Resistance: 100MΩ Min
 Withstanding Voltage: 500V AC/minute
 Terminal: Brass / Tin Plated
 Material:Nylon 66,UL94V-0

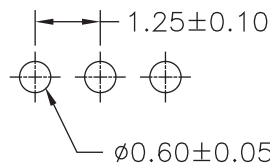

P.C.B LAYOUT

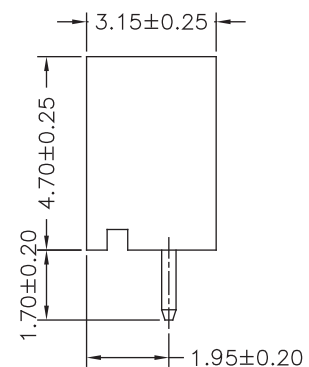
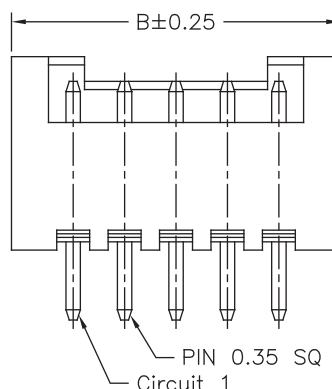
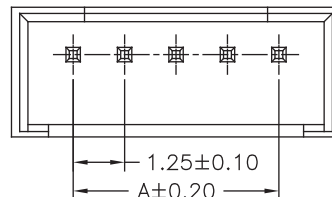

Part No.:1251S-XXTR-L

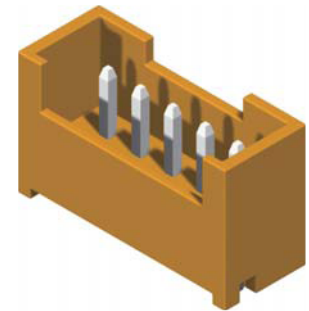



1.25mm Terminal / Housing

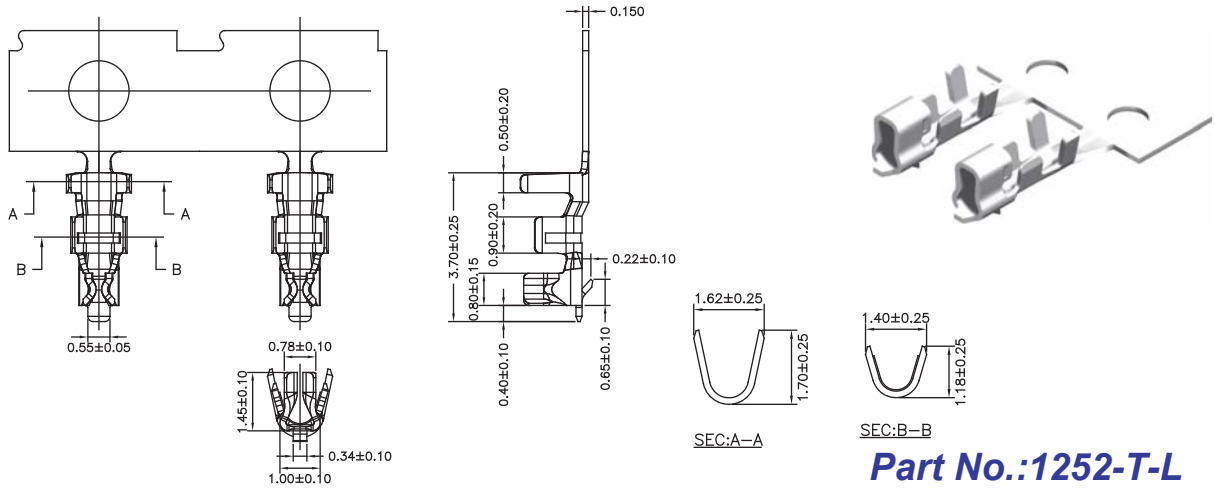

Part No.:1252-T-L

Part No.	Wire Range	Insulation O.D.	Material	Finish
1252-TTP-L	AWG#26-#30	1.00mm(max)	Phosphor Bronze	Tin Plated
1252-TGP-L	AWG#26-#30	1.00mm(max)	Phosphor Bronze	Gold Plated

Specifications

Current Rating: 1A AC,DC
 Voltage Rating: 150V AC,DC
 Temperature Range: -25°C to +85°C
 Contact Resistance: 30mΩ Max
 Insulation Resistance: 500MΩ Min
 Withstanding Voltage: 500V AC/minute
 Material:Nylon 66,UL94V-0

Part No.	Dimensions	
	A	B
1252H-205W-L	5.00	10.40
1252H-207W-L	7.50	12.90
1252H-210W-L	11.25	16.65
1252H-215W-L	17.50	22.90
1252H-220W-L	23.75	29.15

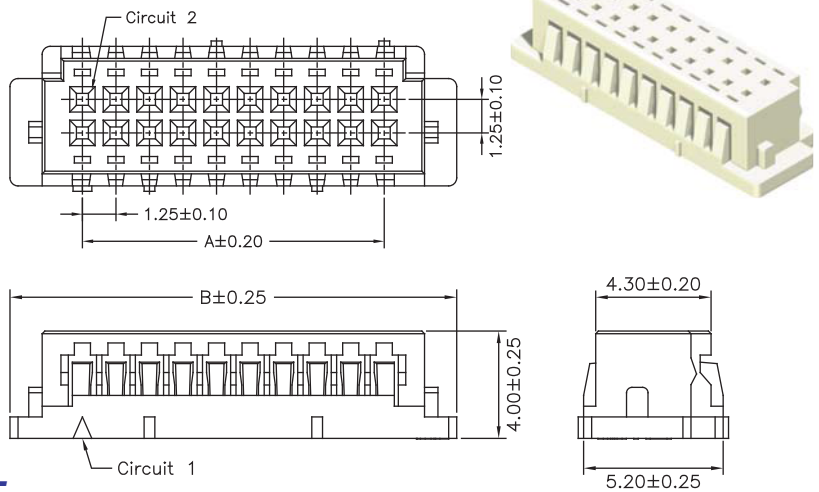

Part No.:1252H-2XXW-L

Specifications

Current Rating: 1A AC,DC
 Voltage Rating: 150V AC,DC
 Temperature Range: -25°C to +85°C
 Contact Resistance: 30mΩ Max
 Insulation Resistance: 500MΩ Min
 Withstanding Voltage: 500V AC/minute
 Material:Nylon 66,UL94V-0

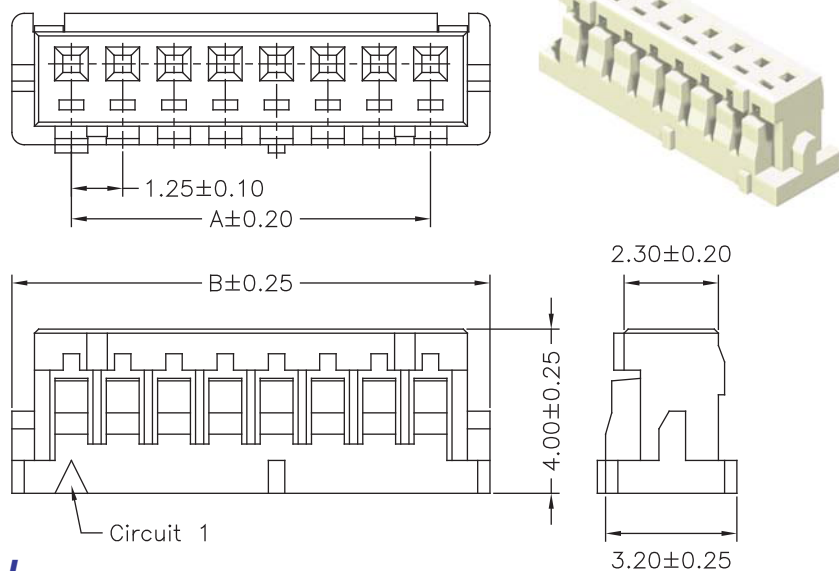

Part No.:1252H-1XXW-L



1.25mm Wafer SMT Straight & SMT R/A Type

Specifications

Current Rating: 1A AC,DC
 Voltage Rating: 150V AC,DC
 Temperature Range: -25°C to +85°C
 Contact Resistance: 30mΩ Max
 Insulation Resistance: 500MΩ Min
 Withstanding Voltage: 500V AC/minute
 Terminal: Brass / Gold Plated
 Solder Tabs: Brass / Gold Plated
 Material:Nylon 6T,UL94V-0

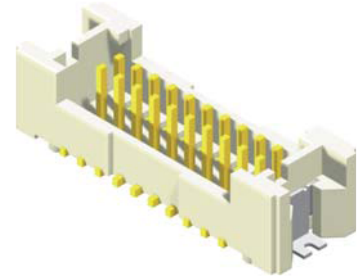
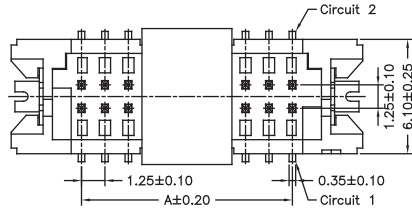

Part No.	Dimensions	
	A	B
1252MS-205GW-U	5.00	12.50
1252MS-207GW-U	7.50	15.00
1252MS-210GW-U	11.25	18.75
1252MS-215GW-U	17.50	25.00
1252MS-220GW-U	23.75	31.25

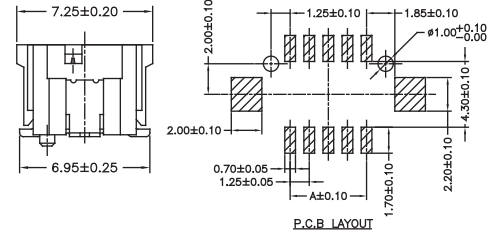
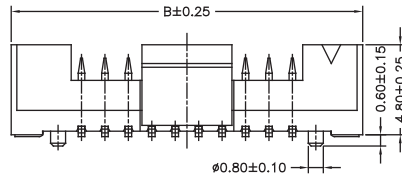

Part No.:1252MS-2XXGW-U

Specifications

Current Rating: 1A AC,DC
 Voltage Rating: 150V AC,DC
 Temperature Range: -25°C to +85°C
 Contact Resistance: 30mΩ
 Insulation Resistance: 500M
 Withstanding Voltage: 500V AC/minute
 Terminal: Brass / Gold Plated
 Solder Tabs: Phosphor Bronze / Gold Plated
 Material:Nylon 6T,UL94V-0

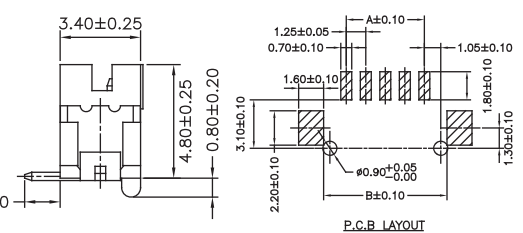
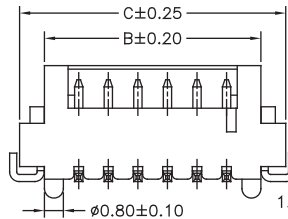
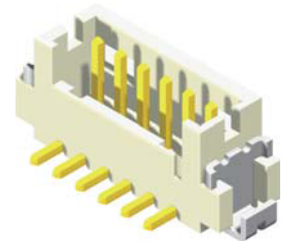
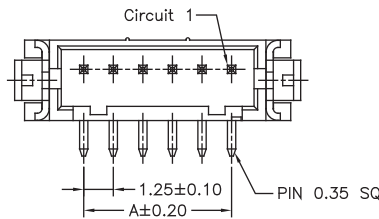

Part No.:1252MS-1XXGW-U

Specifications

Current Rating: 1A AC,DC
 Voltage Rating: 150V AC,DC
 Temperature Range: -25°C to +85°C
 Contact Resistance: 30mΩ
 Insulation Resistance: 500M
 Withstanding Voltage: 500V AC/minute
 Terminal: Brass / Gold Plated
 Solder Tabs: Phosphor Bronze / Gold Plated
 Material:Nylon 6T,UL94V-0

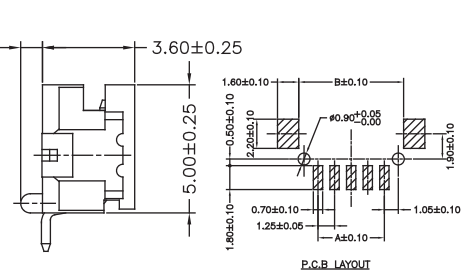
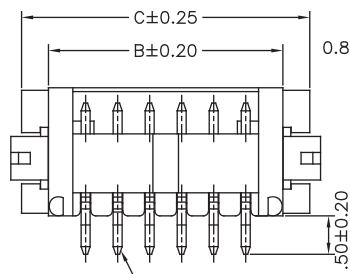
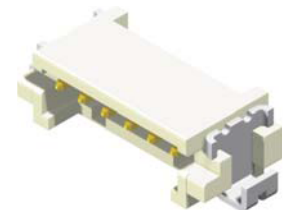
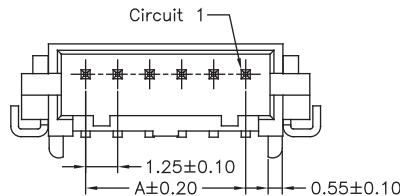

Part No.:1252MR-XXGW-U



1.25mm Wafer Right Angle / Straight Type

Specifications

Current Rating: 1A AC,DC
 Voltage Rating: 150V AC,DC
 Temperature Range: -25°C to +85°C
 Contact Resistance: 30mΩ Max
 Insulation Resistance: 500MΩ Min
 Withstanding Voltage: 500V AC/minute
 Terminal: Brass / Tin Plated
 Material:Nylon 66,UL94V-0

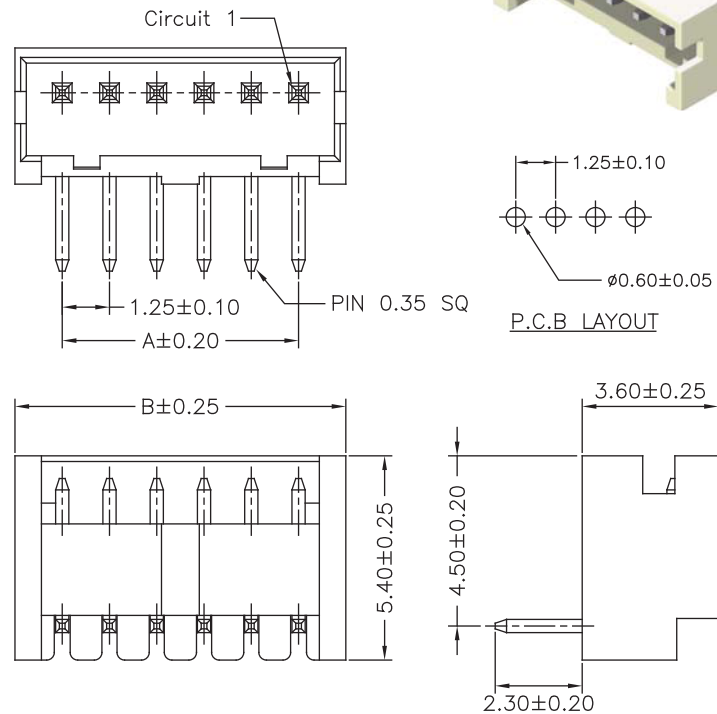

Part No.:1252R-XXTW-L

Specifications

Current Rating: 1A AC,DC
 Voltage Rating: 150V AC,DC
 Temperature Range: -25°C to +85°C
 Contact Resistance: 30mΩ Max
 Insulation Resistance: 500MΩ Min
 Withstanding Voltage: 500V AC/minute
 Terminal: Brass / Tin Plated
 Material:Nylon 66,UL94V-0

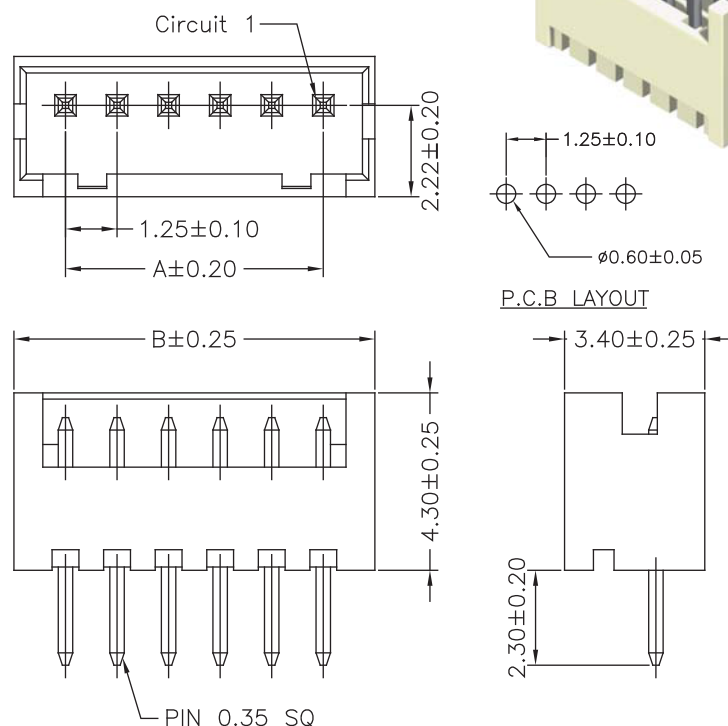

Part No.:1252S-XXTW-L