

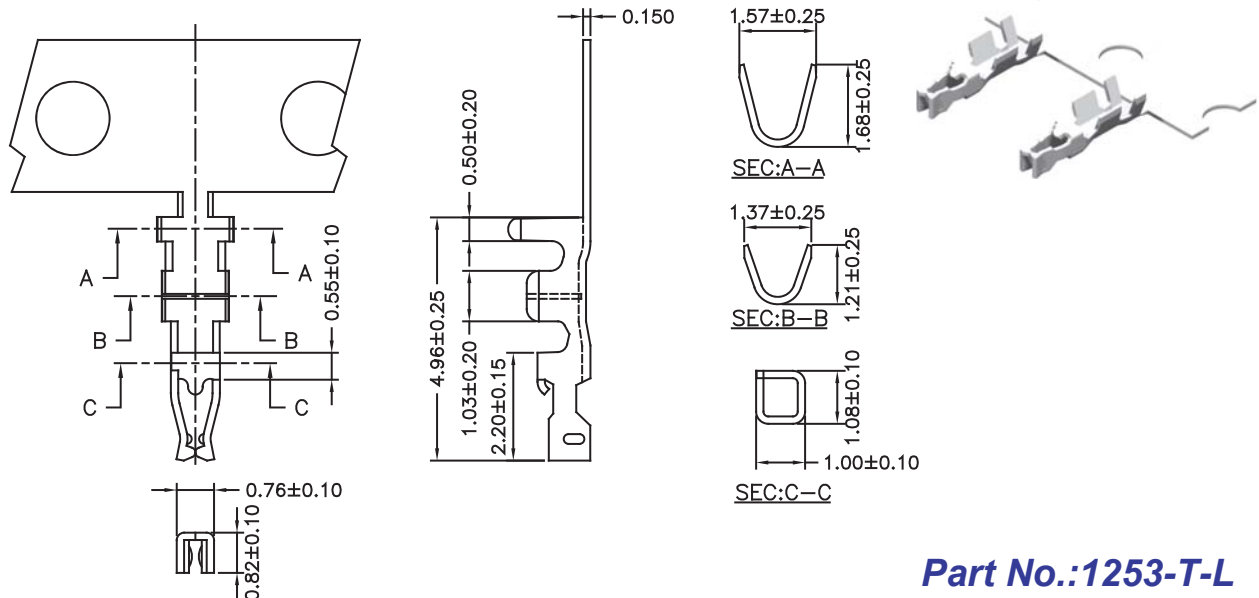

1.25mm Terminal



Part No.:1253-T-L

Part No.	Wire Range	Insulation O.D.	Material	Finish
1253-TGP-L	AWG#26-#32	1.00mm(max)	Phosphor Bronze	Gold Plated
1253-TTP-L	AWG#26-#32	1.00mm(max)	Phosphor Bronze	Tin Plated

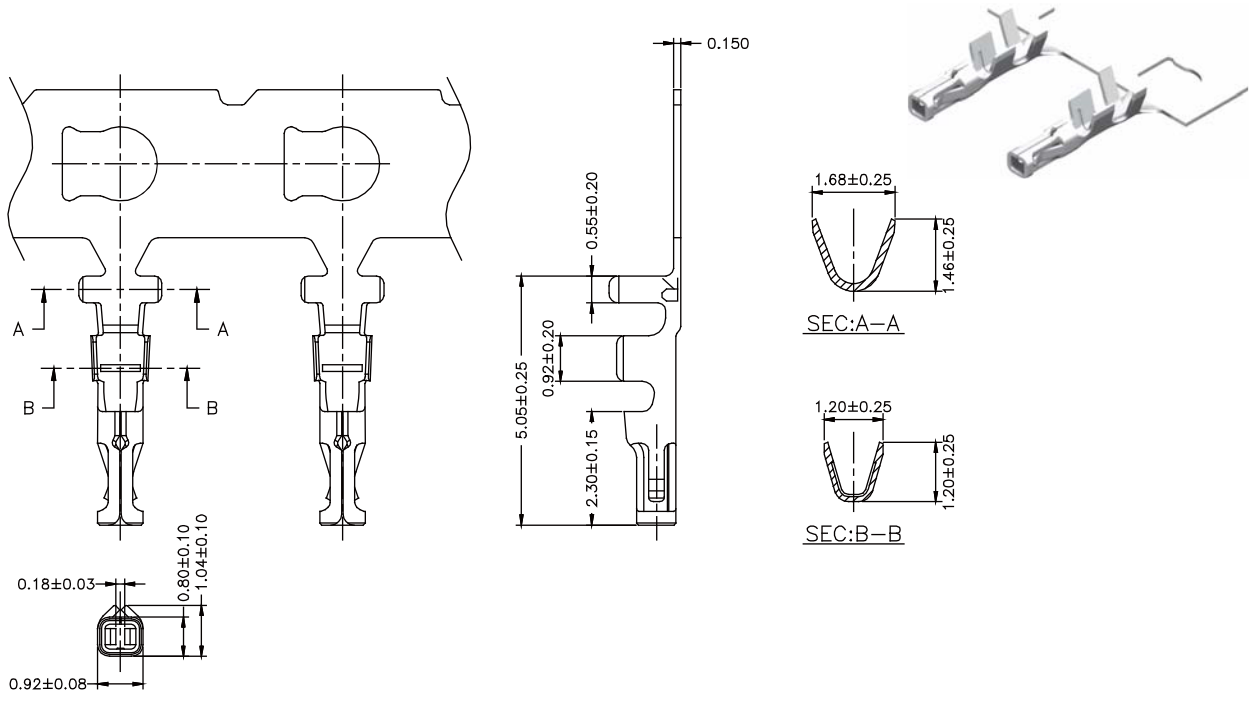

Part No.:1253-T-A-L

Part No.	Wire Range	Insulation O.D.	Material	Finish
1253-TGP-A-L	AWG#28-#32	0.90mm(max)	Phosphor Bronze	Gold Plated
1253-TTP-A-L	AWG#28-#32	0.90mm(max)	Phosphor Bronze	Tin Plated



1.25mm Housing

Specifications

Current Rating: 1A AC,DC
 Voltage Rating: 150V AC,DC
 Temperature Range: -25°C to +85°C
 Contact Resistance: 30mΩ Max
 Insulation Resistance: 500MΩ Min
 Withstanding Voltage: 500V AC/minute
 Material:Nylon 66,UL94V-0

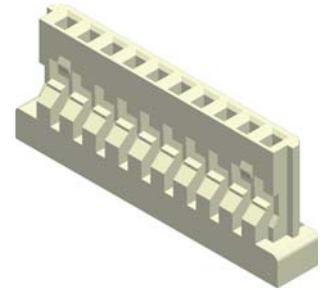

Part No.	Dimensions	
	A	B
1253H-02W-L	1.25	4.25
1253H-03W-L	2.50	5.50
1253H-04W-L	3.75	6.75
1253H-05W-L	5.00	8.00
1253H-06W-L	6.25	9.25
1253H-07W-L	7.50	10.50
1253H-08W-L	8.75	11.75
1253H-09W-L	10.00	13.00
1253H-10W-L	11.25	14.25
1253H-11W-L	12.50	15.50
1253H-12W-L	13.75	16.75
1253H-13W-L	15.00	18.00
1253H-14W-L	16.25	19.25
1253H-15W-L	17.50	20.50
1253H-20W-L	23.75	26.75
1253H-21W-L	25.00	28.00
1253H-25W-L	30.00	33.00
1253H-30W-L	36.25	39.50

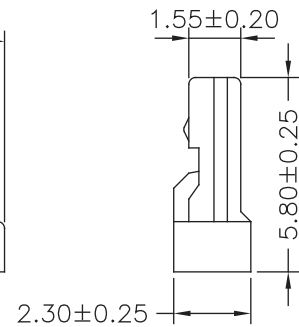
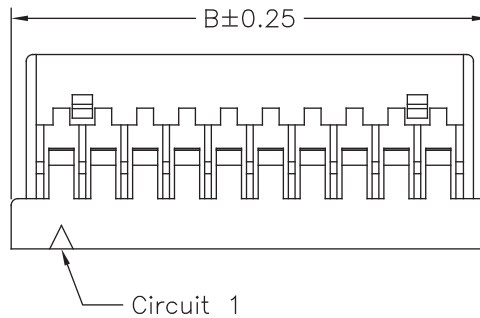
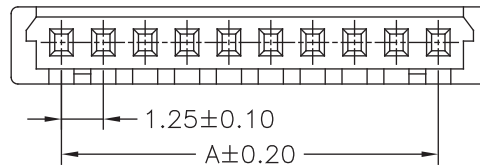

Part No.:1253H-XXW-L

Specifications

Current Rating: 1A AC,DC
 Voltage Rating: 150V AC,DC
 Temperature Range: -25°C to +85°C
 Contact Resistance: 30mΩ Max
 Insulation Resistance: 500MΩ Min
 Withstanding Voltage: 500V AC/minute
 Material:Nylon 66,UL94V-0

Part No.	Dimensions		
	A	B	C
1253HA-02W-L	1.25	4.40	2.75
1253HA-03W-L	2.50	5.65	4.00
1253HA-04W-L	3.75	6.90	5.25
1253HA-05W-L	5.00	8.15	6.50
1253HA-06W-L	6.25	9.40	7.75
1253HA-07W-L	7.50	10.65	9.00
1253HA-08W-L	8.75	11.90	10.25
1253HA-09W-L	10.00	13.15	11.50
1253HA-10W-L	11.25	14.40	12.75
1253HA-11W-L	12.50	15.65	14.00
1253HA-12W-L	13.75	16.90	15.25
1253HA-13W-L	15.00	18.15	16.50
1253HA-14W-L	16.25	19.40	17.75
1253HA-15W-L	17.50	20.65	19.00
1253HA-20W-L	23.75	26.90	25.25
1253HA-25W-L	30.00	33.15	31.50
1253HA-30W-L	36.25	39.40	37.75

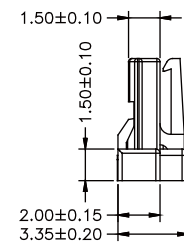
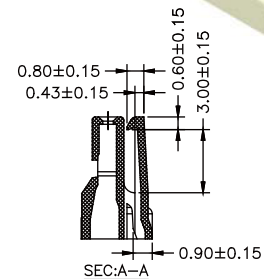
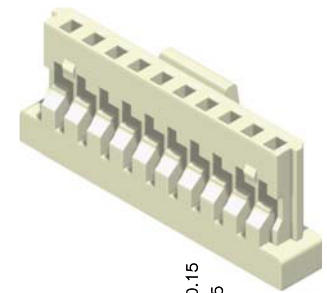
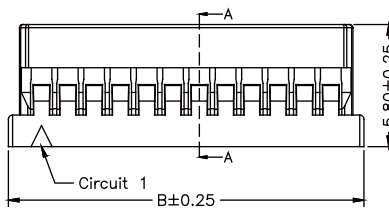
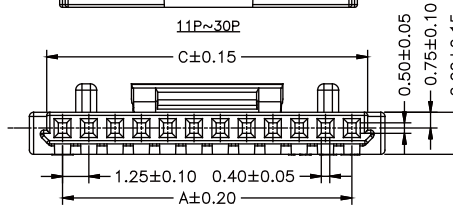
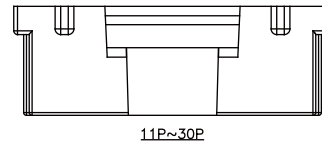
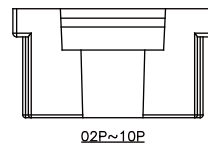

Part No.:1253HA-XXW-L



1.25mm Wafer SMT Straight / SMT R/A Type

Specifications

Current Rating: 1A AC,DC
 Voltage Rating: 150V AC,DC
 Temperature Range: -25°C to +85°C
 Contact Resistance: 30mΩ Max
 Insulation Resistance: 500MΩ Min
 Withstanding Voltage: 500V AC/minute
 Pin Material: Brass / Tin Plated
 Solder Tabs: Brass / Tin Plated
 Material:Nylon 6T,UL94V-0

Part No.	Dimensions	
	A	B
1253MR-02TW-U	1.25	7.45
1253MR-03TW-U	2.50	8.70
1253MR-04TW-U	3.75	9.95
1253MR-05TW-U	5.00	11.20
1253MR-06TW-U	6.25	12.45
1253MR-07TW-U	7.50	13.70
1253MR-08TW-U	8.75	14.95
1253MR-09TW-U	10.00	16.20
1253MR-10TW-U	11.25	17.45
1253MR-11TW-U	12.50	18.70
1253MR-12TW-U	13.75	19.95
1253MR-13TW-U	15.00	21.20
1253MR-14TW-U	16.25	22.45
1253MR-15TW-U	17.50	23.70
1253MR-20TW-U	23.75	29.95
1253MR-25TW-U	30.00	36.20
1253MR-30TW-U	36.25	42.45

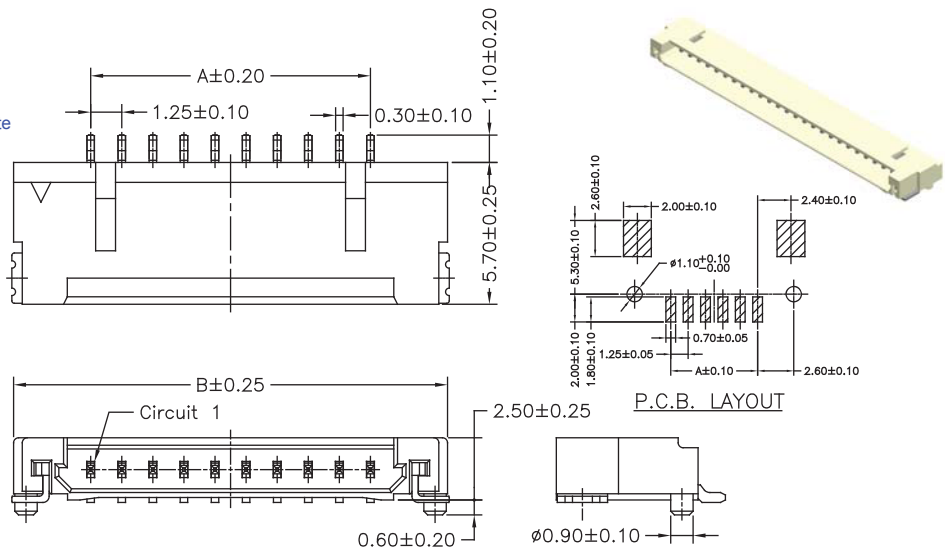

Part No.:1253MR-XXTW-U

Specifications

Current Rating: 1A AC,DC
 Voltage Rating: 150V AC,DC
 Temperature Range: -25°C to +85°C
 Contact Resistance: 30mΩ Max
 Insulation Resistance: 500MΩ
 Withstanding Voltage: 500V AC/minute
 Pin Material: Brass / Tin Plated
 Solder Tabs: Brass / Tin Plated
 Material:Nylon 6T,UL94V-0

Part No.	Dimensions	
	A	B
1253MRA-02TB-U	1.25	7.45
1253MRA-03TB-U	2.50	8.70
1253MRA-04TB-U	3.75	9.95
1253MRA-05TB-U	5.00	11.20
1253MRA-06TB-U	6.25	12.45
1253MRA-07TB-U	7.50	13.70
1253MRA-08TB-U	8.75	14.95
1253MRA-09TB-U	10.00	16.20
1253MRA-10TB-U	11.25	17.45
1253MRA-11TB-U	12.50	18.70
1253MRA-12TB-U	13.75	19.95
1253MRA-13TB-U	15.00	21.00
1253MRA-14TB-U	16.25	22.45
1253MRA-15TB-U	17.50	23.70
1253MRA-20TB-U	23.75	29.95
1253MRA-25TB-U	30.00	36.20
1253MRA-30TB-U	36.25	42.45

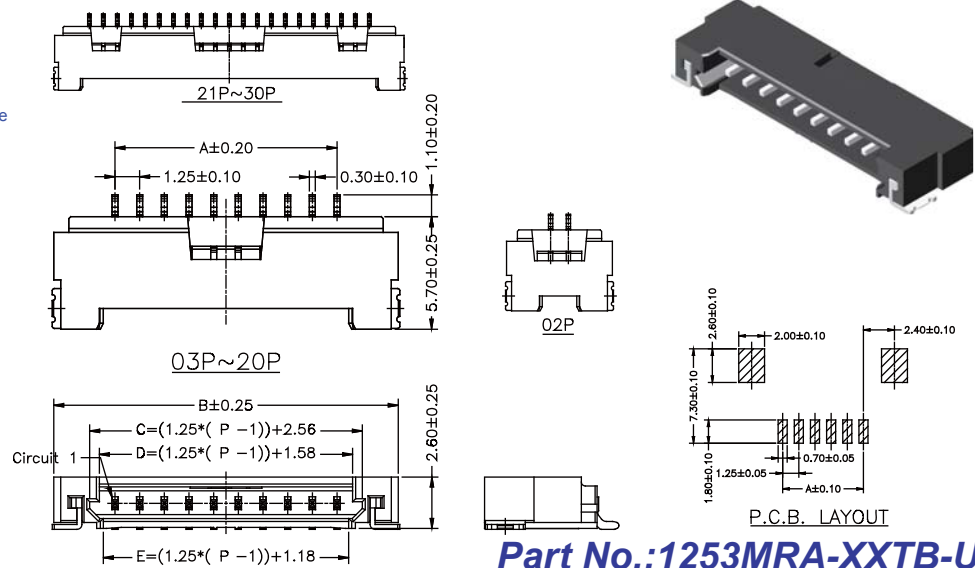

Part No.:1253MRA-XXTB-U

Specifications

Current Rating: 1A AC,DC
 Voltage Rating: 150V AC,DC
 Temperature Range: -25°C to +85°C
 Contact Resistance: 30mΩ Max
 Insulation Resistance: 500MΩ Min
 Withstanding Voltage: 500V AC/minute
 Pin Material: Brass / Tin Plated
 Solder Tabs: Brass / Tin Plated
 Material:Nylon 6T,UL94V-0

Part No.	Dimensions	
	A	B
1253MS-02TB-U	1.25	7.45
1253MS-03TB-U	2.50	8.70
1253MS-04TB-U	3.75	9.95
1253MS-05TB-U	5.00	11.20
1253MS-06TB-U	6.25	12.45
1253MS-07TB-U	7.50	13.70
1253MS-08TB-U	8.75	14.95
1253MS-09TB-U	10.00	16.20
1253MS-10TB-U	11.25	17.45
1253MS-11TB-U	12.50	18.70
1253MS-12TB-U	13.75	19.95
1253MS-13TB-U	15.00	21.00
1253MS-14TB-U	16.25	22.45
1253MS-15TB-U	17.50	23.70
1253MS-20TB-U	23.75	29.95
1253MS-25TB-U	30.00	36.20
1253MS-30TB-U	36.25	42.45

