

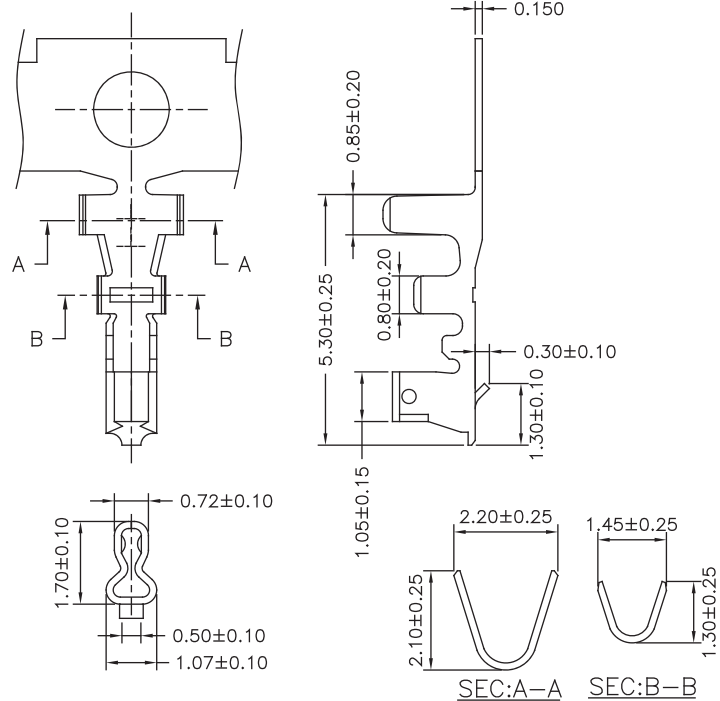

1.5mm Terminal / Housing



Part No.:1501-T-L

Part No.	Wire Range	Insulation O.D.	Material	Finish
1501-TTP-L	AWG#26-#32	1.10mm(max)	Phosphor Bronze	Tin Plated
1501-TGP-L	AWG#26-#32	1.10mm(max)	Phosphor Bronze	Gold Plated

Specifications

Current Rating: 3A AC,DC
 Voltage Rating: 350V AC,DC
 Temperature Range: -25°C to +85°C
 Contact Resistance: 20mΩ Max
 Insulation Resistance: 1000MΩ Min
 Withstanding Voltage: 500V AC/minute
 Material:Nylon 66,UL94V-0

Part No.	Dimensions	
	A	B
1501H-02W-L	1.50	4.10
1501H-03W-L	3.00	5.60
1501H-04W-L	4.50	7.10
1501H-05W-L	6.00	8.60
1501H-06W-L	7.50	10.10
1501H-07W-L	9.00	11.60
1501H-08W-L	10.50	13.10
1501H-09W-L	12.00	14.60
1501H-10W-L	13.50	16.10
1501H-11W-L	15.00	17.60
1501H-12W-L	16.50	19.10
1501H-13W-L	18.00	20.60
1501H-14W-L	19.50	22.10
1501H-15W-L	21.00	23.60

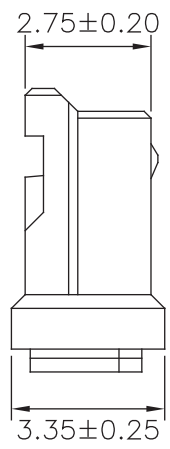
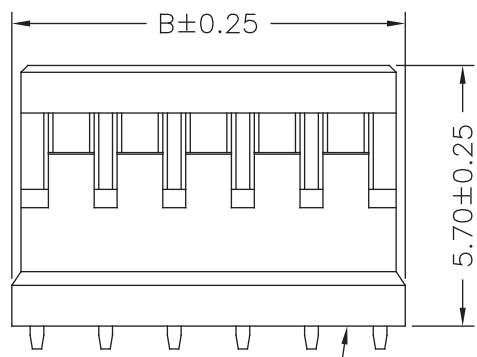
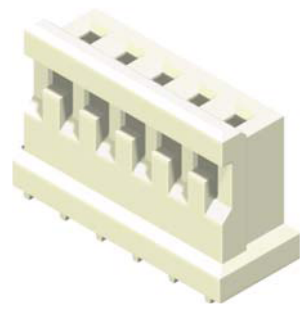
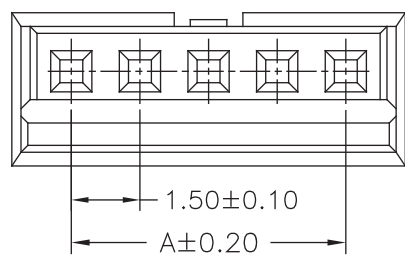

Part No.:1501H-XXW-L



1.5mm Wafer SMT Straight & SMT R/A Type

Specifications

Current Rating: 3A AC,DC
 Voltage Rating: 350V AC,DC
 Temperature Range: -25°C to +85°C
 Contact Resistance: 20mΩ Max
 Insulation Resistance: 1000MΩ Min
 Withstanding Voltage: 500V AC/minute
 Terminal: Brass / Tin Plated
 Material:Nylon 6T,UL94V-0

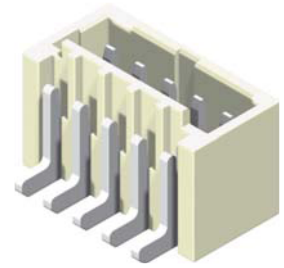

Part No.	Dimensions	
	A	B
1501MS-02TW-U	1.50	4.30
1501MS-03TW-U	3.00	5.80
1501MS-04TW-U	4.50	7.30
1501MS-05TW-U	6.00	8.80
1501MS-06TW-U	7.50	10.30
1501MS-07TW-U	9.00	11.80
1501MS-08TW-U	10.50	13.30
1501MS-09TW-U	12.00	14.80
1501MS-10TW-U	13.50	16.30
1501MS-11TW-U	15.00	17.80
1501MS-12TW-U	16.50	19.30
1501MS-13TW-U	18.00	20.80
1501MS-14TW-U	19.50	22.30
1501MS-15TW-U	21.00	23.80

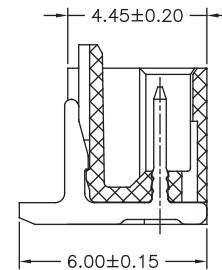
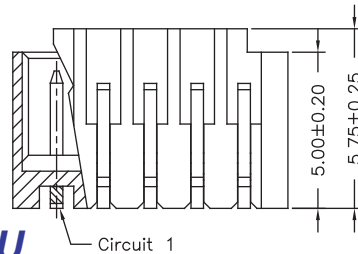
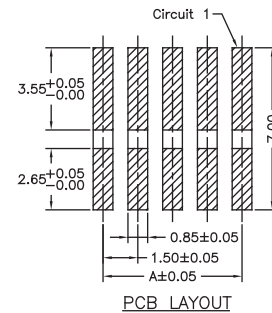
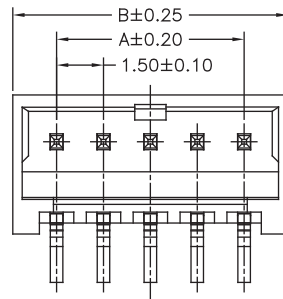

Part No.:1501MS-XXTW-U

Specifications

Current Rating: 3A AC,DC
 Voltage Rating: 350V AC,DC
 Temperature Range: -25°C to +85°C
 Contact Resistance: 20mΩ Max
 Insulation Resistance: 1000MΩ Min
 Withstanding Voltage: 500V AC/minute
 Terminal: Brass / Tin Plated
 Material:Nylon 6T,UL94V-0

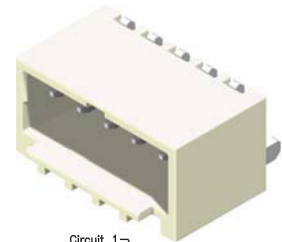

Part No.	Dimensions	
	A	B
1501MR-02TW-U	1.50	4.30
1501MR-03TW-U	3.00	5.80
1501MR-04TW-U	4.50	7.30
1501MR-05TW-U	6.00	8.80
1501MR-06TW-U	7.50	10.30
1501MR-07TW-U	9.00	11.80
1501MR-08TW-U	10.50	13.30
1501MR-09TW-U	12.00	14.80
1501MR-10TW-U	13.50	16.30
1501MR-11TW-U	15.00	17.80
1501MR-12TW-U	16.50	19.30
1501MR-13TW-U	18.00	20.80
1501MR-14TW-U	19.50	22.30
1501MR-15TW-U	21.00	23.80

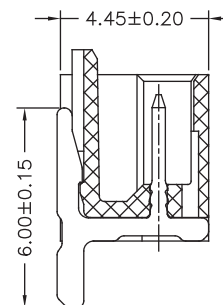
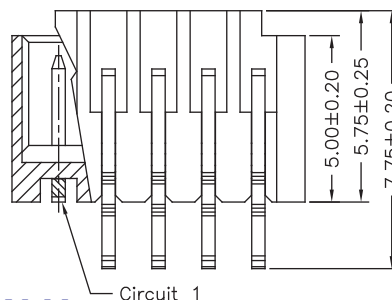
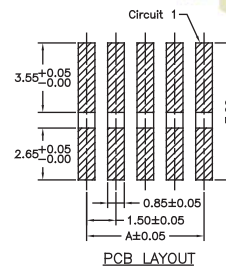
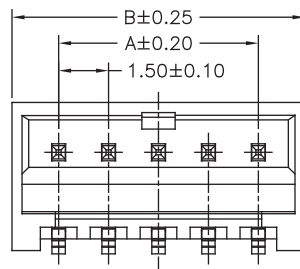

Part No.:1501MR-XXTW-U