

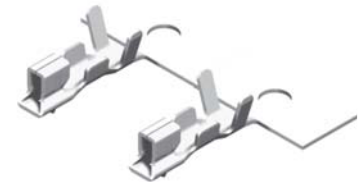

2.5mm Terminal / Housing

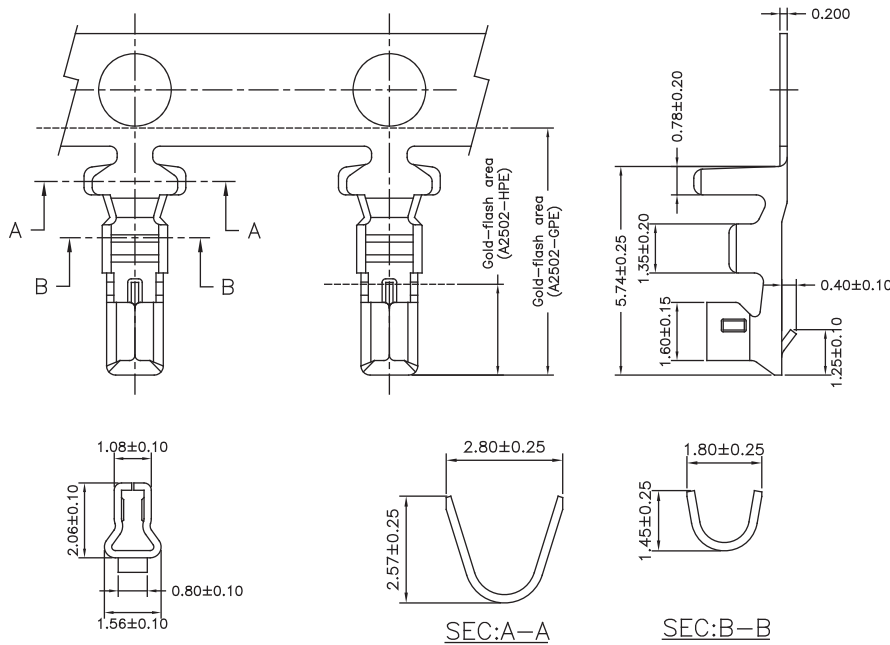

Part No.:2505-T-L

Wire Range	Insulation O.D.	Material	Finish
AWG#22-#30	1.90mm(max)	Phosphor Bronze	Tin Plated

Specifications

Current Rating: 3A AC,DC
 Voltage Rating: 250V AC,DC
 Temperature Range: -25°C to +85°C
 Contact Resistance: 10mΩ Max
 Insulation Resistance: 1000MΩ Min
 Withstanding Voltage: 800V AC/minute
 Terminal: Brass / Tin Plated
 Material: Nylon 66,UL94V-0

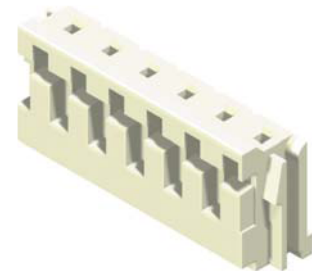

Part No.	Dimensions	
	A	B
2505H-02W-L	2.50	7.00
2505H-03W-L	5.00	9.50
2505H-04W-L	7.50	12.00
2505H-05W-L	10.00	14.50
2505H-06W-L	12.50	17.00
2505H-07W-L	15.00	19.50
2505H-08W-L	17.50	22.00
2505H-09W-L	20.00	24.50
2505H-10W-L	22.50	27.00
2505H-11W-L	25.00	29.50
2505H-12W-L	27.50	32.00
2505H-13W-L	30.00	34.50
2505H-14W-L	32.50	37.00
2505H-15W-L	35.00	39.50

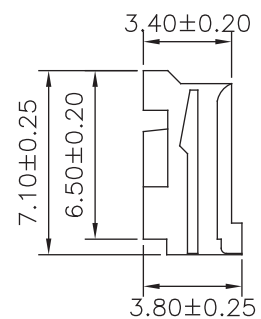
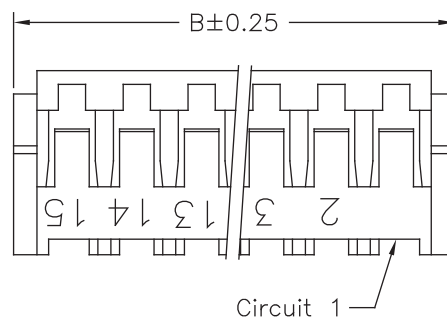
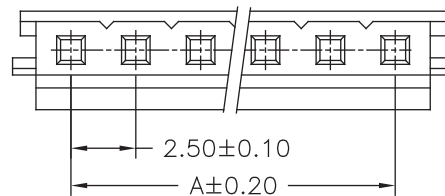

Part No.:2505H-XXW-L



2.5mm Wafer Right Angle / Straight Type

Specifications

Current Rating: 3A AC,DC
 Voltage Rating: 250V AC,DC
 Temperature Range: -25°C to +85°C
 Contact Resistance: 10mΩ Max
 Insulation Resistance: 1000MΩ Min
 Withstanding Voltage: 800V AC/minute
 Terminal: Brass / Tin Plated
 Material: Nylon 66,UL94V-0

Part No.	Dimensions	
	A	B
2505R-02TW-L	2.50	7.50
2505R-03TW-L	5.00	10.00
2505R-04TW-L	7.50	12.50
2505R-05TW-L	10.00	15.00
2505R-06TW-L	12.50	17.50
2505R-07TW-L	15.00	20.00
2505R-08TW-L	17.50	22.50
2505R-09TW-L	20.00	25.00
2505R-10TW-L	22.50	27.50
2505R-11TW-L	25.00	30.00
2505R-12TW-L	27.50	32.50
2505R-13TW-L	30.00	35.00
2505R-14TW-L	32.50	37.50
2505R-15TW-L	35.00	40.00

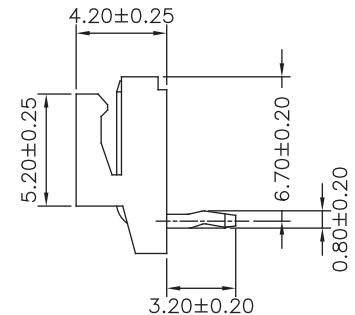
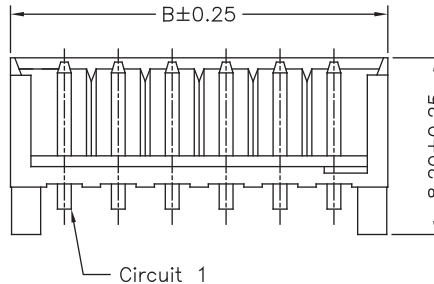
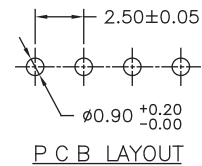
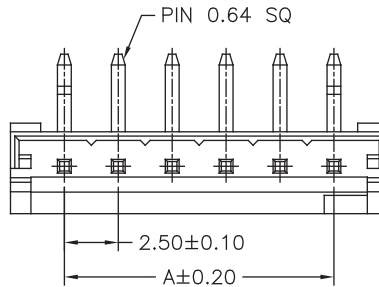

Part No.:2505R-XXTW-L

Specifications

Current Rating: 3A AC,DC
 Voltage Rating: 250V AC,DC
 Temperature Range: -25°C to +85°C
 Contact Resistance: 10mΩ Max
 Insulation Resistance: 1000MΩ Min
 Withstanding Voltage: 800V AC/minute
 Terminal: Brass / Tin Plated
 Material: Nylon 66,UL94V-0

Part No.	Dimensions	
	A	B
2505S-02TW-L	2.50	7.50
2505S-03TW-L	5.00	10.00
2505S-04TW-L	7.50	12.50
2505S-05TW-L	10.00	15.00
2505S-06TW-L	12.50	17.50
2505S-07TW-L	15.00	20.00
2505S-08TW-L	17.50	22.50
2505S-09TW-L	20.00	25.00
2505S-10TW-L	22.50	27.50
2505S-11TW-L	25.00	30.00
2505S-12TW-L	27.50	32.50
2505S-13TW-L	30.00	35.00
2505S-14TW-L	32.50	37.50
2505S-15TW-L	35.00	40.00

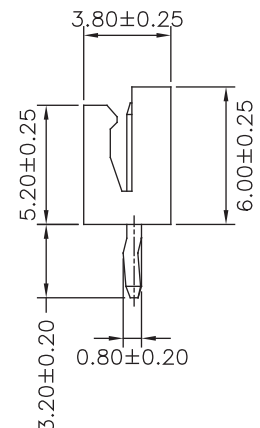
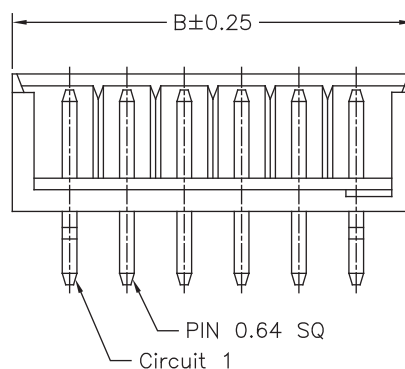
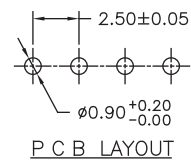
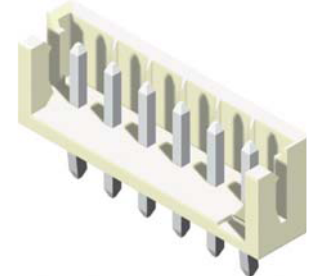
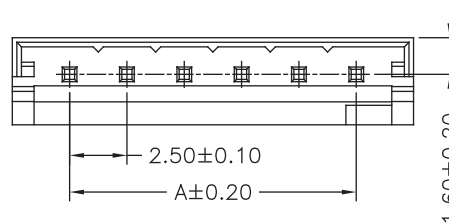

Part No.:2505S-XXTW-L