

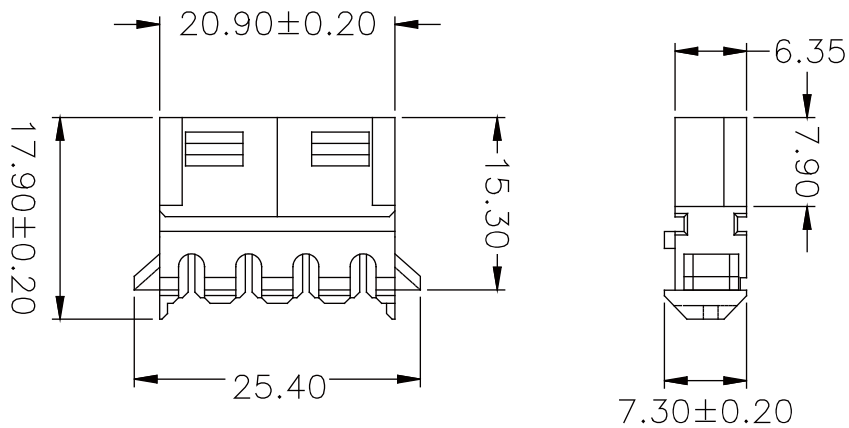

5.08mm Housing IDC Type & Cover

Specifications

Current Rating: 7A AC,DC
 Voltage Rating: 250V AC,DC
 Temperature Range: -25°C to +85°C
 Contact Resistance: 10mΩ Max
 Insulation Resistance: 1000M
 Withstanding Voltage: 1500V AC/minute
 Terminal: Bronze / Tin Plated
 Material: Nylon 66,UL94V-2

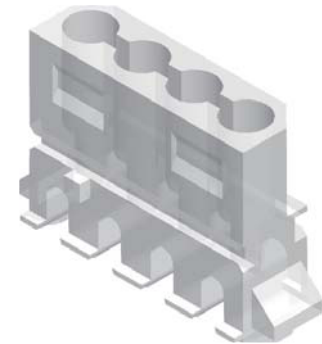
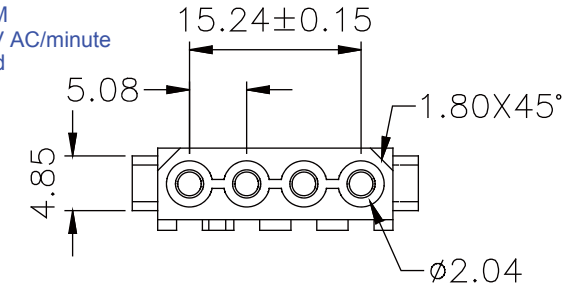

Part No.:5083IDC-04W-L

18:18 AWG
 20:20 AWG
 22:22 AWG

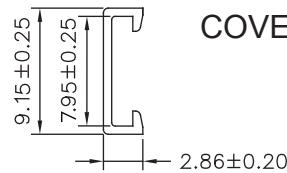
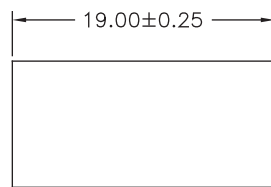

COVER



5083IDC-C-L(Through type)

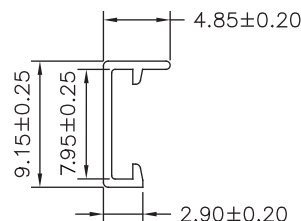
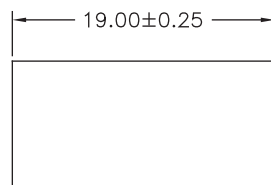

5083IDC-CA-L(end type)

Part No.:5083IDC-C-L